

Nýsköpun & neytendur
Consumers & Products

Vinnsla & virðisaukning
Value Chain & Processing

Erfðir & eldi
Genetics & Aquaculture

Líftækni & lífefni
Biotechnology & Biomolecules

Mælingar & miðlun
Analysis & Consulting

Öryggi & umhverfi
Food Safety & Environment



The effect of liquid cooling at processing and different cooling techniques during transport of cod (*Gadus morhua*) fillets

Hannes Magnússon
Lárus Þorvaldsson
Kolbrún Sveinsdóttir
Hélène L. Lauzon
Kristín Anna Þórarinsdóttir
Sigurjón Arason
Emilía Martindsóttir

Vinnsla og virðisaukning

Skýrsla Matís 34-09
Nóvember 2009

ISSN 1670-7192

Titill / Title	The effect of liquid cooling at processing and different cooling techniques during transport of cod (<i>Gadus morhua</i>) fillets		
Höfundar / Authors	<i>Hannes Magnússon, Lárus Þorvaldsson, Kolbrún Sveinsdóttir, Hélène L. Lauzon, Kristín Anna Þórarinsdóttir, Sigurjón Arason, Emilía Martinsdóttir</i>		
Skýrsla / Report no.	34-09	Útgáfudagur / Date:	November 2009
Verknr. / project no.	1682/1704		
Styrktaraðilar / funding:	AVS R&D Fund of Ministry of Fisheries in Iceland, the Technology Development Fund at the Icelandic Centre for Research and EU (contract FP6-016333-2)		
Ágríp á íslensku:	<p>Tilgangur tilraunanna var að kanna áhrif mismunandi kælitækni og áhrif hitasveiflna á gæði og geymsluþol þorskflaka. Eftirfarandi kælitækni var könnuð: Vökvakæling í pækli við vinnslu miðað við enga kælingu og áhrif hitasveiflna við geymslu í samanburði við stöðugt hitastig (-1°C). Auk þess voru könnuð áhrif þess að nota annars vegar ísmottur og hins vegar þurrís við geymslu flakanna. Fylgst var með breytingum á hitastigi með hitanemum á öllum stigum. Sýni voru gæðametin með skynmati, örveru- og efnamælingum í allt að 14 daga frá veiði (11 daga frá vinnslu og þökkun).</p> <p>Mismunandi meðhöndlun leiddi til mismunandi ferskleikatíma og geymsluþols samkvæmt skynmati. Hópar sem voru vökvakældir við vinnslu höfðu um 2-3 daga skemmra geymsluþol en flök sem ekki voru kæld á þennan hátt. Rekja mátti ástæður þessa til þess að kælipækillinn innihélt töluvert magn örvera m.a. skemmdargerilinn <i>Photobacterium phosphoreum</i> sem er mjög virkur framleiðandi á trimetýlamíni (TMA). Samanburður á vökvakældu flökunum sýndi að notkun á þurrís lengdi geymsluþol um 1-2 daga í samanburði við ísmottur. Geymsla við -1°C hafði ekki merkjanleg áhrif á ferskleikatíma og geymsluþol í samanburði við flök þar sem hitasveiflum var beitt samkvæmt skynmati. Niðurstöður örveru- og efnamælinga voru í samræmi við þessar niðurstöður.</p>		
Lykilorð á íslensku:	<i>Kælitækni, hitasveiflur, þorskflök, ferskleiki, geymsluþol</i>		
Summary in English:	<p>The aim of the experiment was to investigate the effects of different cooling techniques and temperature fluctuations on the storage life of cod fillets. The following cooling techniques were studied: liquid cooling in brine at plant as compared to no special cooling at processing. The effect of real temperature (RTS) simulation during storage was compared to a steady storage temperature at -1°C. Additionally, the influence of using either dry ice or ice packs during storage was studied. The temperature history of each group was studied using temperature loggings. The samples were analysed with sensory evaluation, microbial and chemical methods for up to 14 days from catch (11 days from packaging).</p> <p>The different treatments of the groups resulted in different lengths of freshness period and maximum shelf life according to sensory evaluation. Liquid cooling resulted in a 2-3 days shorter maximum shelf life than the group that was not receiving liquid cooling. This could be attributed to the fact that the cooling brine carried considerable amounts of microbes including the spoilage bacterium <i>Photobacterium phosphoreum</i> which is an active producer of trimethylamine (TMA). Comparison of the groups receiving liquid cooling showed that dry ice appeared to extend the shelf life of 1-2 days as compared to ice packs. Storage at -1°C did not have much influence on the freshness period or maximum shelf life. These results were confirmed by total volatile bases (TVB-N) and TMA analysis and microbial counts.</p>		
English keywords:	<i>Cooling techniques, real temperature simulation, cod fillets, freshness, shelf life</i>		

CONTENTS

1	INTRODUCTION	2
2	MATERIAL AND METHODS	2
2.1	Experimental design	2
2.2	Temperature measurements.....	4
2.3	Sensory evaluation	6
2.4	Microbial measurements	7
2.5	Chemical analysis.....	8
2.5.1	Total Volatile Base Nitrogen (TVB-N) and Trimethylamine (TMA)	8
2.5.2	pH- measurements	8
2.5.3	Salt and water content.....	9
2.6	Determination of water holding capacity (WHC) and drip.....	9
2.7	Data analysis	9
3	RESULTS AND DISCUSSION.....	11
3.1	Temperature measurements.....	11
3.1.1	Temperature in cooling medium.....	11
3.1.2	Ambient temperature	12
3.1.3	Product temperature	13
3.1.4	Summary	15
3.2	Sensory evaluation	17
3.3	Microbial measurements	22
3.4	Chemical measurements.....	24
3.4.1	Total Volatile Base Nitrogen (TVB-N) and Trimethylamine (TMA)	24
3.4.2	pH – measurements.....	25
3.4.3	Salt content and water content	26
3.5	Water holding capacity (WHC) and drip	26
4	CONCLUSION.....	28
5	ACKNOWLEDGEMENTS	28
6	REFERENCES	28
7	APPENDIX I	30

1 INTRODUCTION

Rapid cooling after catch and maintenance of low temperature throughout the whole chain from catch to consumer is the prerequisite of high quality and long shelf life of fish products.

The aim of the experiment was to investigate effects of different cooling techniques and temperature fluctuations on the storage life of cod fillets. The following cooling techniques were studied: liquid cooling in brine at plant as compared to no special cooling at processing and the effect of real temperature (RTS) simulation during storage compared to a steady storage temperature at -1°C . Additionally, the influence of using either dry ice or ice packs during storage was studied. The temperature history of each group was studied using temperature loggers. The samples were analysed with sensory evaluation, microbial and chemical methods for up to 14 days from catch (11 days from packaging).

2 MATERIAL AND METHODS

2.1 Experimental design

Cod used in the experiment was caught by a trawler north of Iceland (262/263) on March 16th 2009.



Figure 1. The trawler, Sólbakur EA 1, that caught the fish processed for the trial. (http://www.ua.is/skipin/solbakur_ea_1/?nocache=true).

After bleeding and gutting the cod was washed in sea-water on deck and then transported to the hold where it was iced with slurry ice in tubs. The cod was processed at a fish processing plant in North Iceland, March 19th 2009. The fish was filleted and fillets

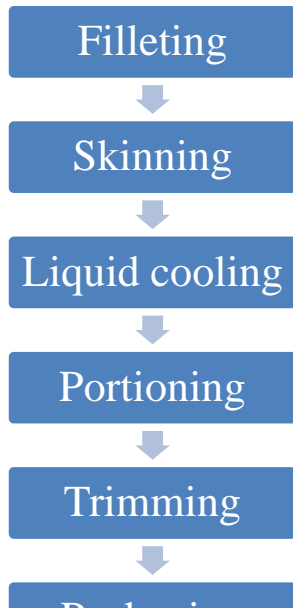

Figure 2: Processing of cod at Brim fish processing plant

without skin got different treatment (see below) prior to packaging in 5 kg Styrofoam boxes. After packaging the cod was transported to Matís ohf where it was stored either at -1°C or under real temperature simulation for up to 14 days from catch (11 days from packaging).

The experimental groups were as follows:

K. Liquid cooling (LC) at plant, packaged with ice packs in Styrofoam boxes and storage under real temperature simulation (RTS) at Matís.

L. No cooling (NC) at plant, packaged with ice packs in Styrofoam boxes and storage under real temperature simulation (RTS) at Matís.

M. Liquid cooling (LC) at plant, packaged with ice packs in Styrofoam boxes and storage at -1°C at Matís.

N. Liquid cooling (LC) at plant, packaged with dry ice in Styrofoam boxes and storage under real temperature simulation (RTS) at Matís.

The following abbreviations of experimental groups will be used hereafter:

- K. LC-IP-RTS
- L. NC-IP-RTS
- M. LC-IP-S
- N. LC-DI-RTS

Sampling was done one day after processing and every few days up to 11 days after processing as shown in Table 1.

Table 1: Sampling days for the experiment. RTS = real temperature simulation

Group	Treatment	Storage	Sampling days
LC-IP-RTS	Liquid cooling	Ice packs, RTS	1, 4, 6, 8, 11
NC-IP-RTS	No cooling	Ice packs, RTS	1, 4, 6, 8, 11
LC-IP-S	Liquid cooling	Ice packs, -1°C	1, 4, 6, 8, 11
LC-DI-RTS	Liquid cooling	Dry ice, RTS	1, 4, 6, 8, 11

2.2 Temperature measurements

Two types of thermometers were used for temperature logging:

- a. iButton temperature loggers (Figure 3), type DS1922L. (http://www.maxim-ic.com/quick_view2.cfm/qv_pk/4088). This logger has an accuracy of $\pm 0.5^{\circ}\text{C}$ and a resolution of 0.0625°C and an operating range of -40 to 85°C . The diameter is 17 mm and the thickness is 5 mm. The iButton loggers were used in the experiments for measuring the product temperature. They were placed in plastic bags, in order to avoid microbial contamination.
- b. Onset temperature loggers (Figure 3), type UTBI-001 (<http://www.onsetcomp.com/products/data-loggers/utbi-001>). These loggers have an accuracy of ± 0.2 and a resolution of 0.02°C and an operating range of -20 to 70°C . The diameter is 30 mm and the thickness is 17mm. Those loggers were used for measuring ambient temperature in climate chambers.

Four iButton temperature loggers were put in each Styrofoam box and two on the outside of each box. Five Onset temperature loggers were used in each climate chamber for measuring ambient temperature.



Figure 3: An iButton temperature logger (left) and an Onset temperature logger (right).

Figure 4 shows the location of the temperature loggers inside the Styrofoam boxes. The numbering scheme used in Figure 4 is consistent with Table 2. The names used for each logger hereafter are also displayed in Table 2.

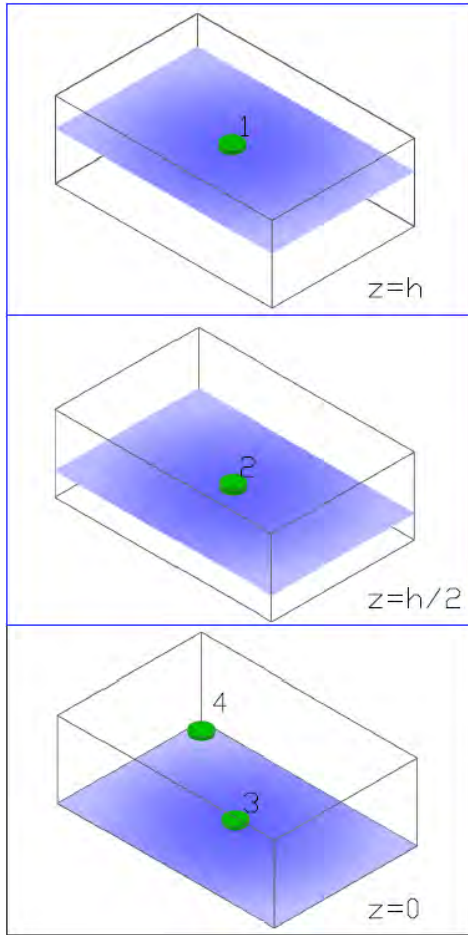

Table 2: Location and numbering scheme of temperature loggers.

#	horiz. location	vert. location	name
1	middle	top	top
2	middle	middle	middle
3	middle	bottom	bottom
4	corner	bottom	corner

Figure 4: Location of temperature loggers inside each box.

2.3 Sensory evaluation

Quantitative Descriptive Analysis (QDA), introduced by Stone and Sidel (2004), and the Torry freshness score sheet (Shewan and others 1953) were used to assess cooked samples (MA09sky043-051) of cod (Table 3). Ten panellists all trained according to international standards (ISO 1993); including detection and recognition of tastes and odours, trained in the use of scales and in the development and use of descriptors participated in the sensory evaluation. The members of the panel were familiar and experienced in using the QDA method and Torry freshness score sheet for cod. The panel was trained in recognition of sensory characteristics of the samples and describing the intensity of each attribute for a given sample using an unstructured scale (from 0 to 100%). Most of the attributes were defined and described by the sensory panel during other projects (Sveinsdottir et al 2009). The sensory attributes were 30 and are described in Table 2.

Samples weighing ca. 40 g were taken from the loin part of the fillets and placed in aluminium boxes coded with three-digit random numbers. The samples were cooked for 6 minutes in a pre-warmed oven (Convotherm Elektrogeräte GmbH, Eglfing, Germany) at 95-100°C with air circulation and steam, and then served to the panel. Each panellist evaluated duplicates of each sample in a random order in nine sessions (maximum four samples per session).

A computerized system (FIZZ, Version 2.0, 1994-2000, Biosystèmes-) was used for data recording.

Table 3: Sensory vocabulary for cooked samples of cod (*Gadus morhua*)

Sensory attribute	Short name	Description of attribute
Odour		
sweet	o-sweet	sweet odour
shellfish, algae	o-shellfish	shellfish, algae, characterict fresh odour
meaty	o-meat	meaty odour, reminds of boiled meat or halibut
vanilla, boiled milk	o-vanilla	vanilla, sweet boiled milk
boiled potatoes	o-potatoes	odour reminds of whole, warm, boiled potatoes
frozen storage	o-frozen	reminds of odour found in refrigerator and/or freezing compartment
table cloth	o-cloth	reminds of damp, unclean cloth (left on kitchen table for 36 h)
TMA	o-TMA	TMA odour, reminds of dried salted fish, amine
sour	o-sour	sour odour, spoilage sour, acetic acid
sulphur	o-sulphur	sulphur, matchstick, boiled kale
Appearance		
light/dark colour	a-dark	Left end: light, white colour. Right end: dark, yellowish, brownish, grey
homogenous/ heterogeneous	a-heterog.	Left end: homogenous, even colour. Right end: discoloured, heterogeneous, stains
white precipitation	a-prec.	white precipitation in the broth or on the fish
Flavour		
salt	f-salt	salt taste
metallic	f-metallic	metallic flavour
sweet	f-sweet	characteristic sweet flavour of very fresh (boiled) cod
meaty	f-meat	meaty flavour, reminds of boiled meat
frozen storage	f-frozen	reminds of food which has soaked in refrigerator/freezing odour
pungent	f-pungent	pungent flavour, bitter
sour taste	f-sour	sour taste, spoilage sour
TMA	f-TMA	TMA flavour, reminds of dried salted fish, amine
off flavour	f-off	strenght of off flavour (spoilage flavour/off-flavour)
Texture		
flakiness	t-flakes	the fish portion slides into flakes when pressed with the fork
firm/soft	t-soft	Left end: firm. Right end: soft. Evaluate how firm or soft the fish is during the first bite
dry/juicy	t-juicy	Left end: dry. Right end: Juicy. Evaluated after chewing several times: dry - pulls juice from the mouth
tough/tender	t-tender	Left end: tough. Right end: tender. Evaluated after chewing several times
mushy	t-mushy	mushy texture
meaty	t-meaty	meaty texture, meaty mouth feel, grude muscle fibers
clammy	t-clammy	clammy texture, dry red wine, tannin
rubbery	t-rubbery	rubbery texture, springy

2.4 Microbial measurements

In all counts surface-plating was used. Total viable psychrotrophic counts (TVC) and counts of H₂S-producing bacteria were evaluated on iron agar (IA) as described by Gram and others (1987) with the exception that 1% NaCl was used instead of 0.5% with no

overlay. Plates were incubated at 17°C for 4-5 d. Bacteria forming black colonies on IA produce H₂S from sodium thiosulphate and/or cysteine. Cephaloridine Fucidin Ceftrimide (CFC) agar was modified according to Stanbridge and Board (1994) and used for enumeration of presumptive pseudomonads. Pseudomonas Agar Base (Oxoid) with CFC Selective Agar Supplement (Oxoid) was used. Plates were incubated at 22°C for 3 d. *Pseudomonas* spp. form pink colonies on this medium. Counts of *Photobacterium phosphoreum* were estimated by using the PPDM-Malthus conductance method (Dalgaard and others 1996), as described by Lauzon (2003).

In all experiments, cooled Maximum Recovery Diluent (MRD, Oxoid) was used for dilutions. All samples were analysed in triplicate and results presented as an average.

2.5 Chemical analysis

2.5.1 Total Volatile Base Nitrogen (TVB-N) and Trimethylamine (TMA)

The method of Malle and Tao (1987) was used for total volatile bases (TVB-N) and trimethylamine (TMA) measurements. TVB-N was measured by steam distillation (Struer TVN distillatory, STRUERS, Copenhagen) and titration, after extracting the fish muscle with 7.5% aqueous trichloroacetic acid solution. The distilled TVB-N was collected in boric acid solution and then titrated with sulphuric acid solution. TMA was measured in trichloroacetic acid (TCA) extract by adding 20 ml of 35% formaldehyde, an alkaline binding mono- and diamine, TMA being the only volatile and measurable amine. All chemical analyses were done in triplicate.

2.5.2 pH- measurements

The pH was measured in 5 grams of minced loins mixed with 5 mL of deionised water using the Radiometer PHM 80. The pH meter was calibrated using the buffer solutions of pH 7.00 ± 0.01 and 4.01 ± 0.01 (25°C) (Radiometer Analytical A/S, Bagsvaerd, Denmark).

2.5.3 *Salt and water content*

The water content of each fillet was measured by accurately weighing out 5 grams of the minced sample in a ceramic bowl with sand. The sample was then mixed to the sand and dried in an oven at 103 ± 2 °C for 4 hours. The water content was based on weight differences before and after the drying of three replicates for each sample (ISO 6496, 1999). Salt content was measured with the Volhard Titrimetric method according to AOAC ed. 17 from 2000 (no. 976.18).

2.6 **Determination of water holding capacity (WHC) and drip**

The water holding capacity (WHC) was determined by a centrifugation method (Eide and others 1982). Approximately 2 g of the minced fish was weighed accurately and centrifuged (Heraeus Biofuge Stratos, Kendro Laboratory products, USA) at 210 x g, for 5 minutes at 0-5°C. The weight lost during centrifugation ($\Delta m_{centrifuged}$) was evaluated as water loss and no corrections made for other components as may be necessary for fishes with high fat content. WHC was calculated as the ratio of the water retained in the sample, compared to mass of water before centrifugation ($m_t * x_t^w$):

$$WHC = \left(\frac{m_t * x_t^w - \Delta m_{centrifuged}}{m_t * x_t^w} \right) * 100$$

Drip was evaluated through the storage by measuring the weight of the liquid which drained from the fillets in the boxes. The weight of the fish was also recorded. The drip was then calculated as the ratio of the liquid lost during storage to the original weight of the fish.

2.7 **Data analysis**

Principal Component Analysis (PCA) on significant mean values of QDA sensory attributes was performed, using full cross validation. Analysis of variance (ANOVA) was carried out on QDA data as well as for microbial and chemical data in the statistical

program NCSS 2000 (NCSS, Utah, USA) (see Tables A-E in Appendix 1). The program calculates multiple comparisons using Duncan's multiple comparison test. The significance level was set at 5%, if not stated elsewhere.

3 RESULTS AND DISCUSSION

3.1 Temperature measurements

3.1.1 *Temperature in cooling medium*

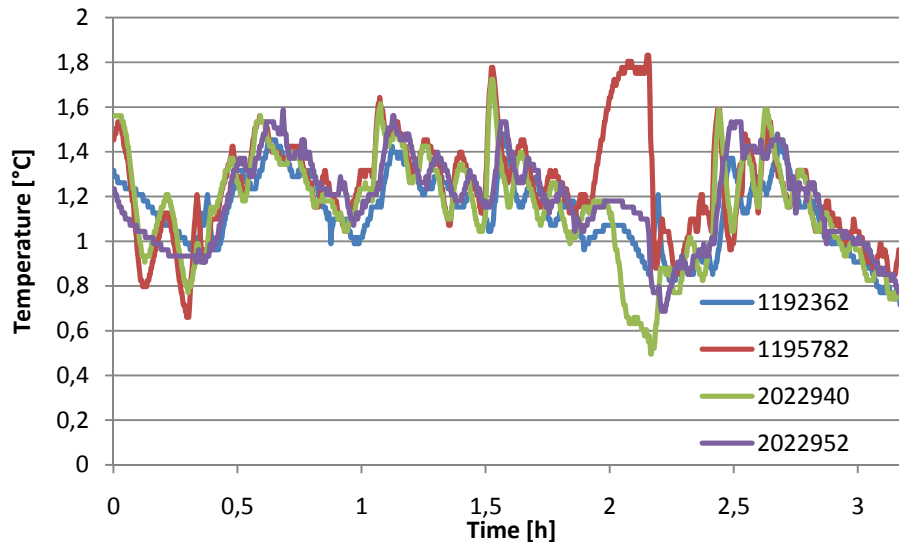

Figure 5: Temperature in the cooling medium of the liquid cooler during the period which the experiment was carried out.

Figure 5 shows the temperature of the cooling medium at four different locations in the liquid cooler during the period which the experiment was carried out. The average temperature over the entire sampling period was $1.2 \pm 0.2^\circ\text{C}$. The temperature of the raw material was usually around $1.0\text{--}2.2^\circ\text{C}$ and went through the liquid cooler in approximately 5 minutes. For the raw material at the highest temperature the liquid cooling usually resulted in a cooling of 0.4°C or from 2.1°C to 1.7°C . However the material which was initially below 1°C tended to stay at a similar temperature or even slightly raise its temperature.

3.1.2 Ambient temperature

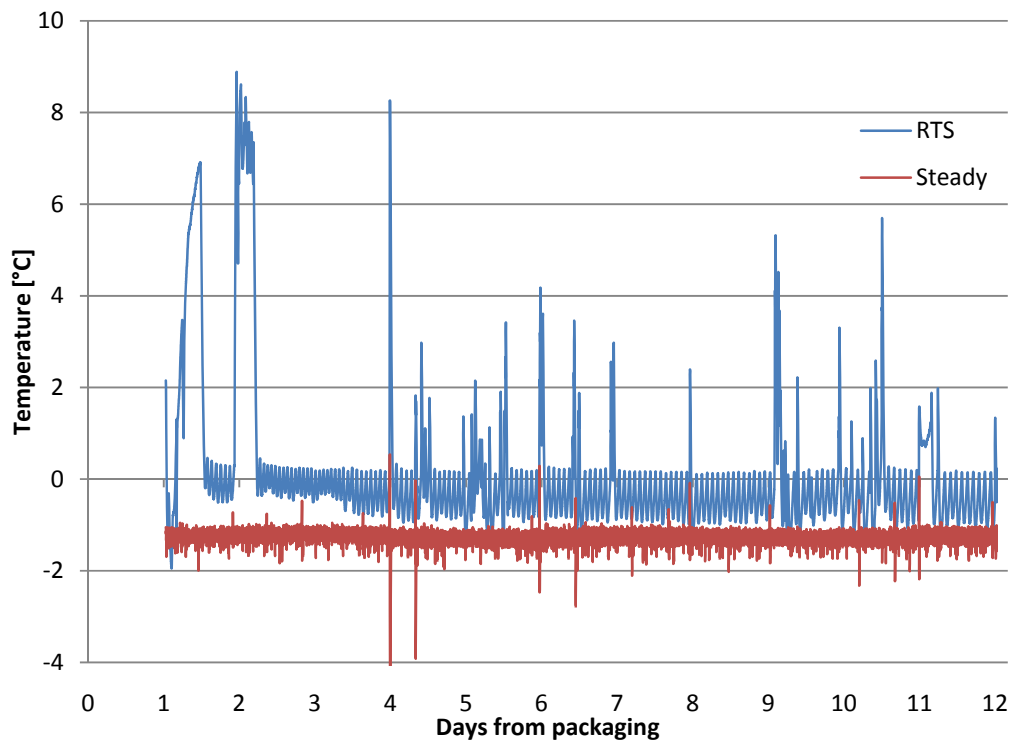

Figure 6: Temperature in the the real temperature simulation (RTS) and the steady climate chamber.

Figure 6 shows how the real temperature simulation was performed as well as the temperature in the steady climate chamber. The boxes arrived at Matís facilities at 10:30 on the morning of 20th of March 2009. The boxes which belonged to the RTS groups were then inserted into a climate chamber with air temperature $3.0\pm 2.9^{\circ}\text{C}$. After 12 hours the temperature was lowered down to $-0.0\pm 0.5^{\circ}\text{C}$ for 12 hours and then raised again to $7.2\pm 0.8^{\circ}\text{C}$ for 6 hours. At last the temperature was kept at a steady $-0.2\pm 0.8^{\circ}\text{C}$ for the remaining storage period. The groups subjected to steady temperature were put in a climate chamber where a temperature of $-1.3\pm 0.2^{\circ}\text{C}$ was maintained during the entire storage period.

3.1.3 Product temperature

Figure 7 to Figure 9 show the development of temperature in the groups where RTS was applied. Figure 10 shows the temperature of the group subjected to steady -1°C during the storage period.

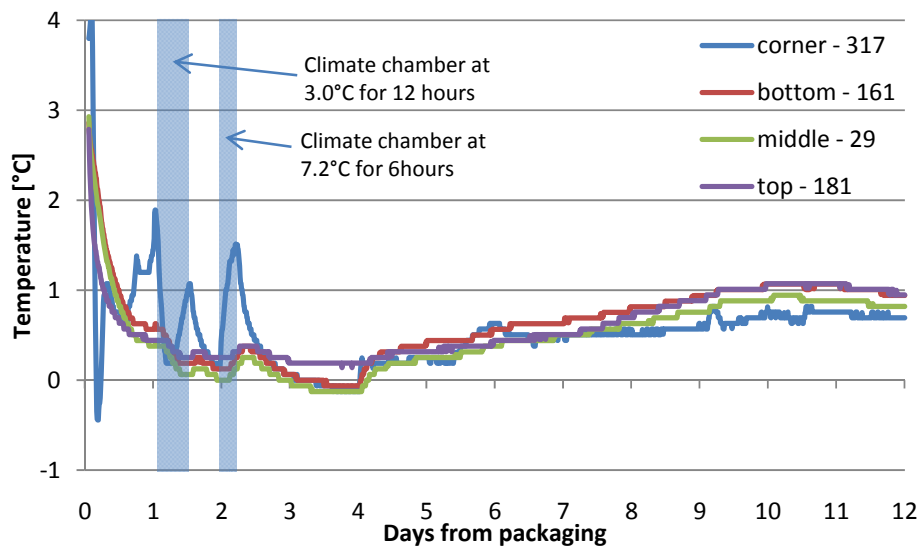

Figure 7: Group K: LC-IP-RTS – Liquid cooled, packed with ice packs and subjected to RTS

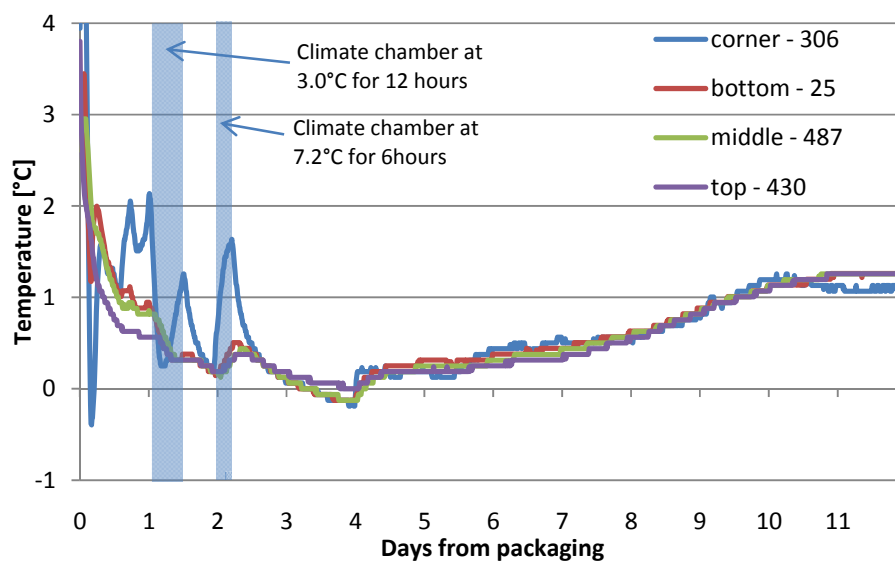

Figure 8: Group L: NC-IP-RTS – Packed right after filleting without ice packs and subjected to RTS

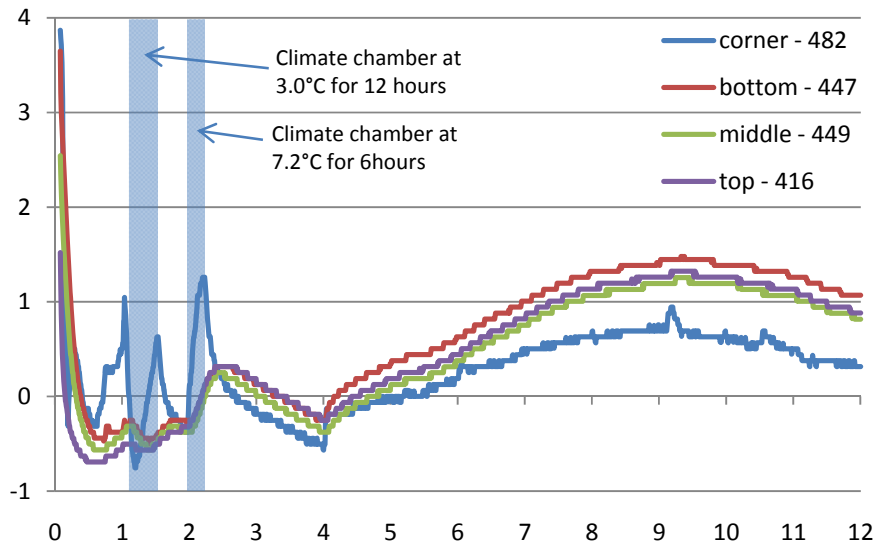

Figure 9: Group N: LC-DI-RTS – Liquid cooled, packed with dry ice and subjected to RTS

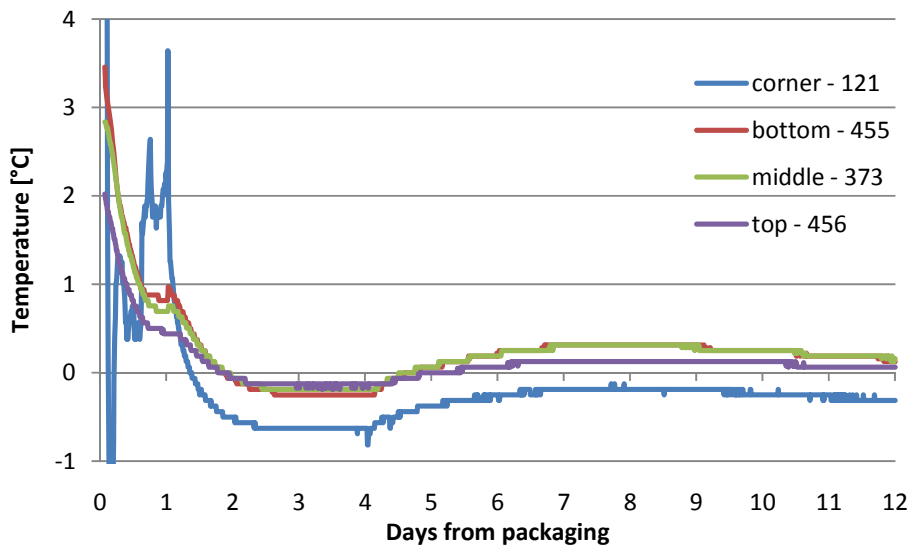

Figure 10: Group M: LC-IP-S – Liquid cooled, packed with ice packs and stored at a steady -1°C

Figure 7 to Figure 10 show that the location which is the most sensitive to external temperature load is the bottom corner location, where it responds much faster to any external temperature load than the temperature at the other locations which were observed. At the centre of the box the temperature response is dampened and lags behind the external temperature load which is applied.

Figure 7 to Figure 10 also show that the temperature distribution is rather homogenous along the centre of the box where the temperature difference is usually less than 0.2°C.

The influence of dry ice on temperature can clearly be seen by comparing Figure 9 to Figure 7 and Figure 8. After 12 hours from packaging the groups where only ice packs were applied are at 0.8°C-1.1°C while the group where dry ice was applied reached -0.5°C after 12 hours from packaging. The group which was cooled with dry ice also maintained lower temperature than the other groups which were subjected to RTS.

At the end of day 3 groups K and L reach a minimum temperature of approximately 0°C. An interesting feature in the temperature development of the RTS groups (K, L and N) is that at the beginning of day 4 the temperature suddenly increases. A possible explanation for this is the spike in ambient temperature which can be seen on Figure 6 at the beginning of day 4, which could initiate exothermic reactions in the spoilage process.

The final temperature is similar in all the groups which were subjected to RTS or approximately 1°C. The final temperature of the group which was kept at a steady -1°C is on the other hand 0°C and has less temperature fluctuations during the storage period.

3.1.4 Summary

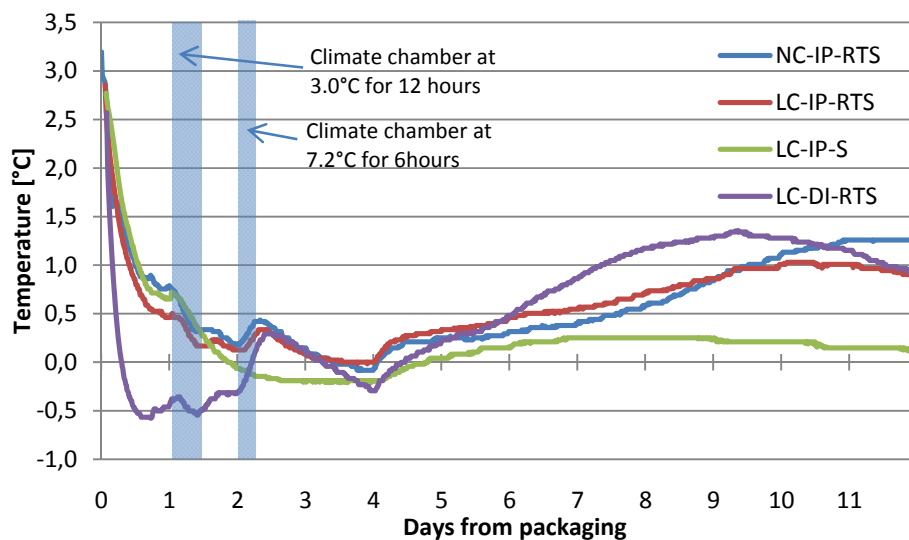

Figure 11: Average temperature history of all the groups during transportation and storage at Mafis facilities.

Figure 11 shows the average temperature of all the experiment groups. The average temperature in each group is found by taking the mean of the three centre locations, top, middle and bottom at each time step. The figure shows that there does not seem to be a significant difference between groups K and L in average temperature during the storage

period. The only difference in treatment between those two groups was that the former received liquid cooling while the other was packed right after filleting. As can be seen from Table 4 the average temperature during the 12 day storage period was 0.6°C in both groups. However the initial temperature of the group which was cooled with liquid cooling (2.9°C) was slightly lower than the one which did not receive any cooling (3.2°C) and also seemed to cool slightly faster during the initial days of the storage period.

Table 4: Average product temperature during storage

	group	mean	stdev
K	LC-IP-RTS	0.6	0.4
L	NC-IP-RTS	0.6	0.5
M	LC-IP-S	0.2	0.4
N	LC-DI-RTS	0.5	0.6

Dry ice seems to have a significant effect on the product temperature during the first days of storage where average product temperature reaches approximately -0.5°C in 12 hours while the groups where ice packs were applied are still at 0.8°C-1.1°C after 12 hours.

3.2 Sensory evaluation

Figure 12 shows how the samples were characterised by the sensory attributes. Altogether 95% of the sensory variation was explained in the first two principal components. The main variation between the samples was due to differences explained by storage time. Sensory attributes characteristic for cod at the beginning of storage, such as sweet and metallic flavour, sweet and shellfish odours are located to the left in the lower part of Figure 12b describing samples after one day of storage (Figure 12a). As storage time progressed, these sensory attributes become less evident but the vanilla odour and juicy texture become more characteristic, and then potato odour, dark and discoloured appearance (upper part of Figure 12b). The sensory attributes characteristic for cod at the end of storage, such as TMA and sour flavours and odours, located to the right in the lower region are used to describe the samples at the end of the storage period. No clear differences were observed between the groups with regard to sensory characteristics. The sample group NC-IP-RTS (control group) appeared to be less described by spoilage related sensory attributes at the end of storage as compared to other groups. On storage day 11, the control group had similar characteristics as LC-IP-RTS and LC-IP-S on day eight. Sample group LC-DI-RTS however, was mainly characterized by spoilage related sensory attributes on storage day 11 (Figure 12a). Tables A-D in Appendix 1 show in more detail how the sample groups were characterized by sensory attributes.

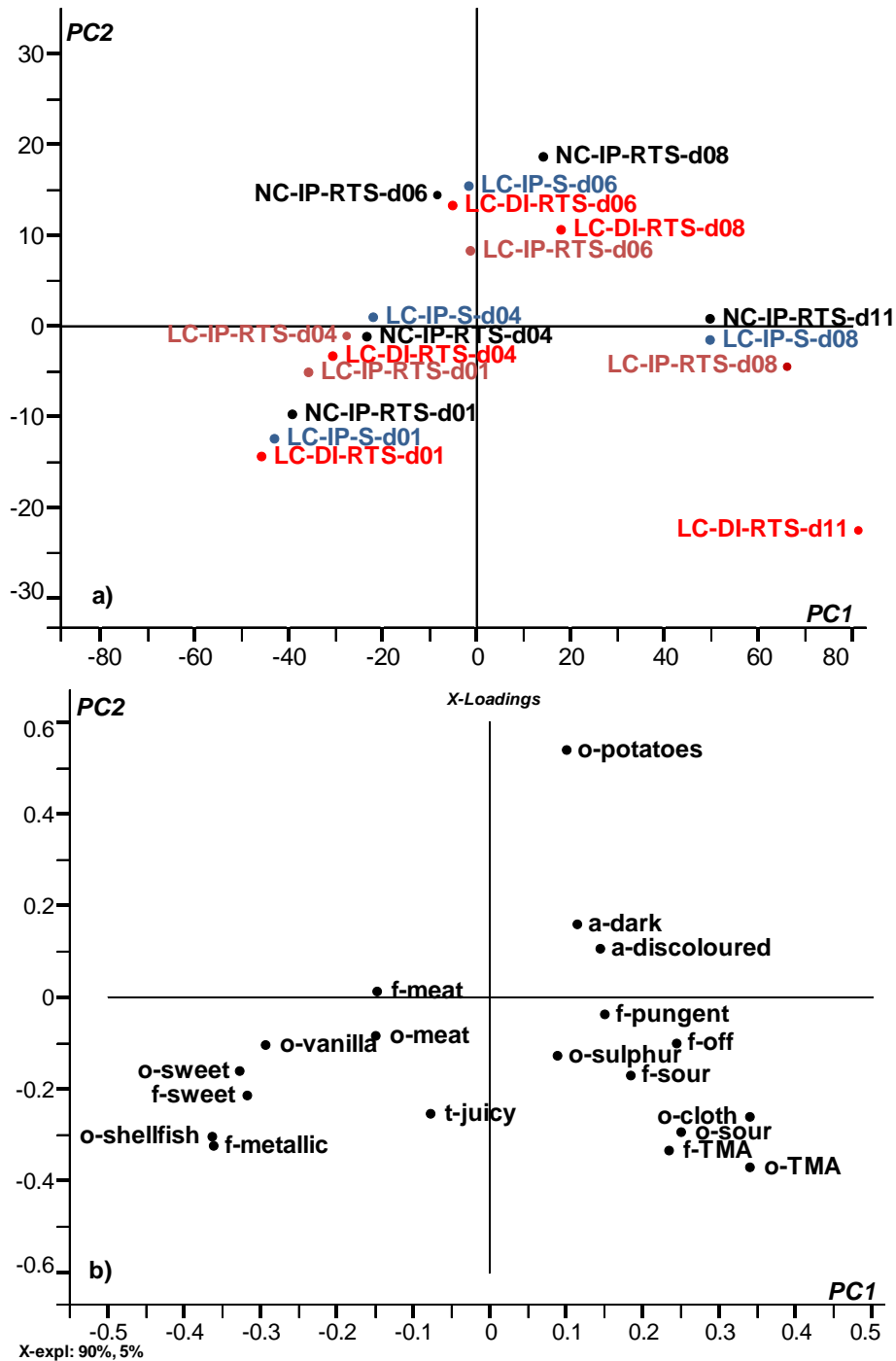

Figure 12. PCA describing sensory quality, odour (o-), appearance(a-), flavour (f-) and texture (t-) of the sample groups with storage time (d). PC1 VS PC2 (X-expl.: 90% and 5%). a) scores, b) X-loadings.

Figure 13 shows how the Torry freshness score changes with storage time. A Torry score around 7 indicates the fish has lost most of its freshness odour and flavour characteristics, and has a rather neutral odour and flavour (Shewan and others 1953). These limits were obtained after 5-6 days for all groups. When the average Torry score is around 5.5 most of the sensory panellists detect spoilage attributes, and these limits have been used as the limits for consumption at Mafís (see e.g. Olafsdottir and others 2006). According to this, the maximum shelf life of LC-IP-RTS was 7 days, LC-IP-S 7-8 days, LC-DI-RTS 8-9 days and NC-IP-RTS 9 days

Figure 14 shows how the sweet flavour changed with storage time. When the score for this attribute is around 25-30, the fish has lost most of its characteristic sweet flavour. NC-IP-RTS has reached these limits after around 5-7 days, LC-IP-RTS and LC-IP-S after around 6-7 days, but LC-DI-RTS after 6-8 days, which was somewhat longer period than what was observed from the Torry score.

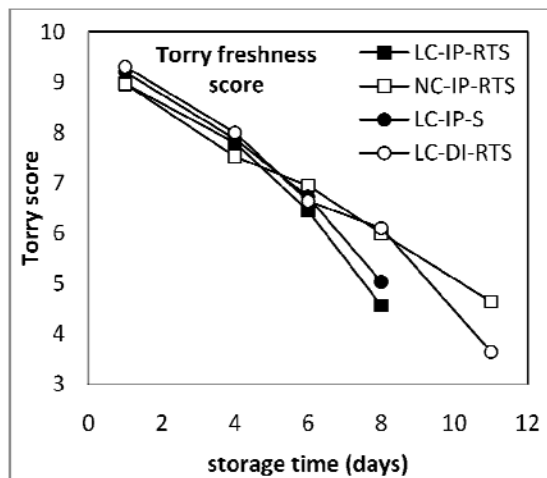

Figure 13. Average Torry freshness scores

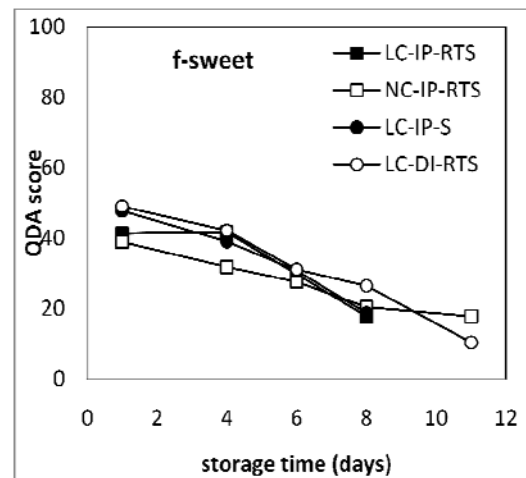

Figure 14. Average QDA scores of sweet flavour

Figures 15-20 show how odour and flavour attributes related to spoilage change with storage time. A part of the panel could not taste the samples due to spoilage, which explains the inconsistency between odour and flavour with regard to intensity of sourness. End of shelf life is usually determined when sensory attributes related to spoilage become evident. When the average QDA score for those attributes is above the

value 20 (on the scale 0 to 100) most panellists detect them (Bonilla and others 2007; Magnússon and others 2006). According to this criterion, the maximum shelf life of LC-IP-RTS was 7 day, LC-IP-S 7-8 days, LC-DI-RTS 8-9 days and NC-IP-RTS 9-10 days. These results are in agreement with the results from the Torry scores.

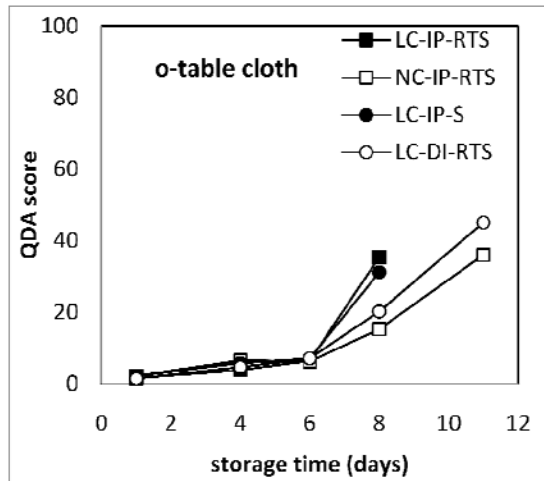

Figure 15. Average QDA scores of table cloth odour

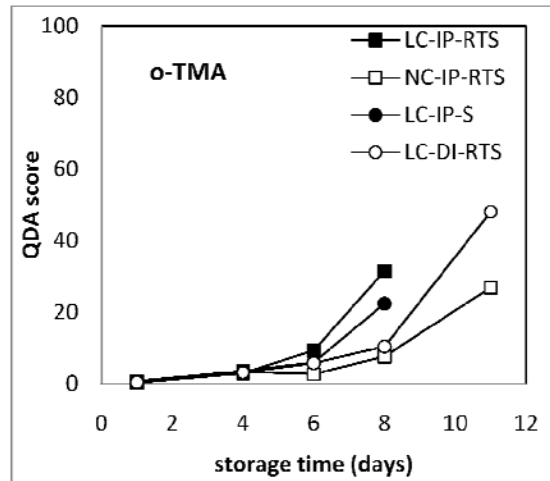

Figure 16. Average QDA scores of TMA odour

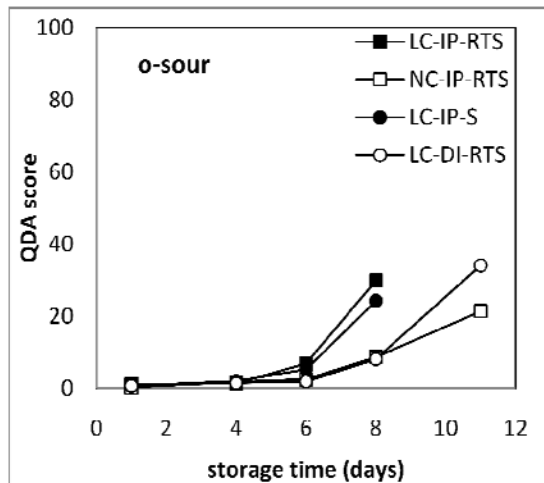

Figure 17. Average QDA scores of sour odour

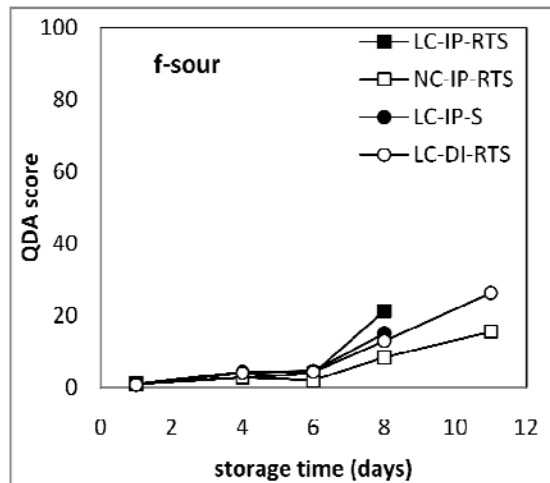

Figure 18. Average QDA scores of sour flavour

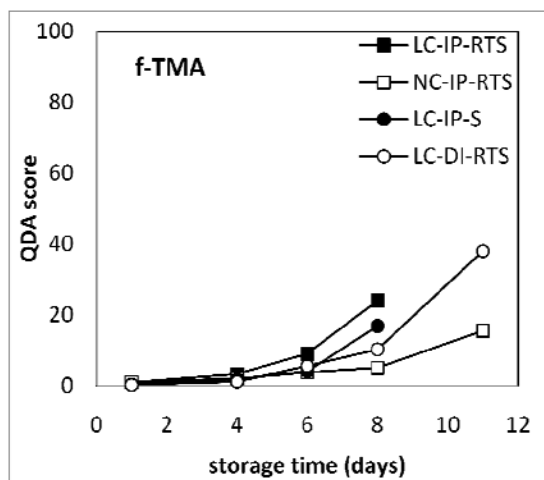

Figure 19. Average QDA scores of TMA flavour

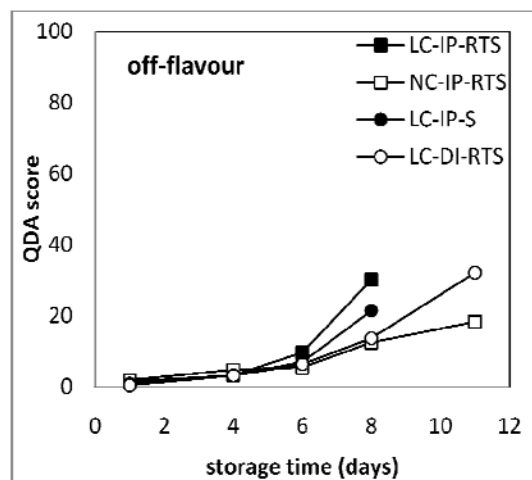

Figure 20. Average QDA scores of off-flavour

A comparison of the freshness period (the end of this period is when the fish has lost the freshness characteristics and reached the neutral phase) and the maximum shelf life (the end of this period is when odour and flavour attributes related to spoilage have become evident) is shown in Table 5.

The different treatments of the groups did not influence the sensory characteristics of the samples in other ways than resulting in different lengths of freshness period and maximum shelf life. The estimation of these periods was based on freshness and spoilage related odour and flavour attributes. Thus, liquid cooling resulted in a 2-3 days shorter maximum shelf life than the group that was not receiving the liquid cooling treatment (NC-IP-RTS compared to LC-IP-RTS). Comparison of the groups receiving liquid cooling showed that dry ice appeared to extend the shelf life of 1-2 days as compared to ice packs (LC-DI-RTS compared to LC-IP-RTS), but storage at -1°C did not have much influence on the freshness period or maximum shelf.

Table 5. Freshness period and maximum shelf life according to sensory evaluation

Group	freshness period	shelf life
LC-IP-RTS	5-7	7
NC-IP-RTS	5-7	9-10
LC-IP-S	5-7	7-8
LC-DI-RTS	5-8	8-9

3.3 Microbial measurements

Initial microbial counts in brine and skinless cod fillets at the day of processing (3 day post-catch) are shown in Figure 21. Considerable load of microbes was found in the brine. It is evident that higher microbial counts were found in the fillets that were immersed into the cooling brine compare to the control fillets (no cooling). It is therefore clear that the fillets have picked up microbes from the brine. This was especially noticeable for the spoilage bacterium *Photobacterium phosphoreum* which increased from about 10/g in the control group up to about 40.000/g during the immersion process.

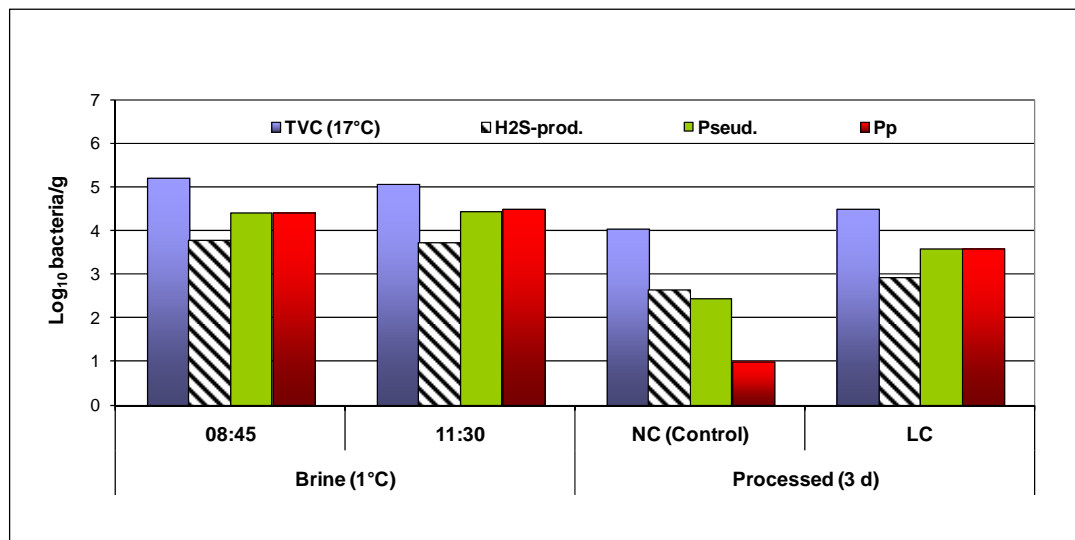

Figure 21. Initial microbial load in brine and skinless cod fillets at the day of processing (LC: Liquid cooling, NC: No cooling, TVC: Total viable counts, H₂S-prod: H₂S-producing bacteria, Pseud: presumptive pseudomonads, Pp: *Photobacterium phosphoreum*).

Microbial counts in the four experimental groups of cod fillets during storage from day of packaging for up to 11 days are shown in Figures 22-23. From day 4 onwards, similar growth curves were obtained for TVC and *P. phosphoreum* for all experimental groups (Figure 22). Growth curves for H₂S-producing bacteria and pseudomonads were also similar but much lower counts were obtained (Figure 23).

Generally minor differences were found between experimental groups within each sampling day during storage. Significant differences ($p < 0.05$) were only found at the beginning of the experiment and on day 11. Thus, TVC, *P. phosphoreum* and

pseudomonads were significantly lower in the control group (no cooling) on day 0 than in the group where liquid cooling was applied prior to packaging. On the last day of sampling (day 11), TVC were lower in the no cooling group (NC-IP-RTS) than in the LC-IP-RTS group. H₂S-producing bacterial counts were higher in the group LC-IP-RTS than in other groups on day 11 and pseudomonads counts were significantly higher in the group NC-IP-RTS compared to the LC-DI-RTS group (see table E in Appendix 1).

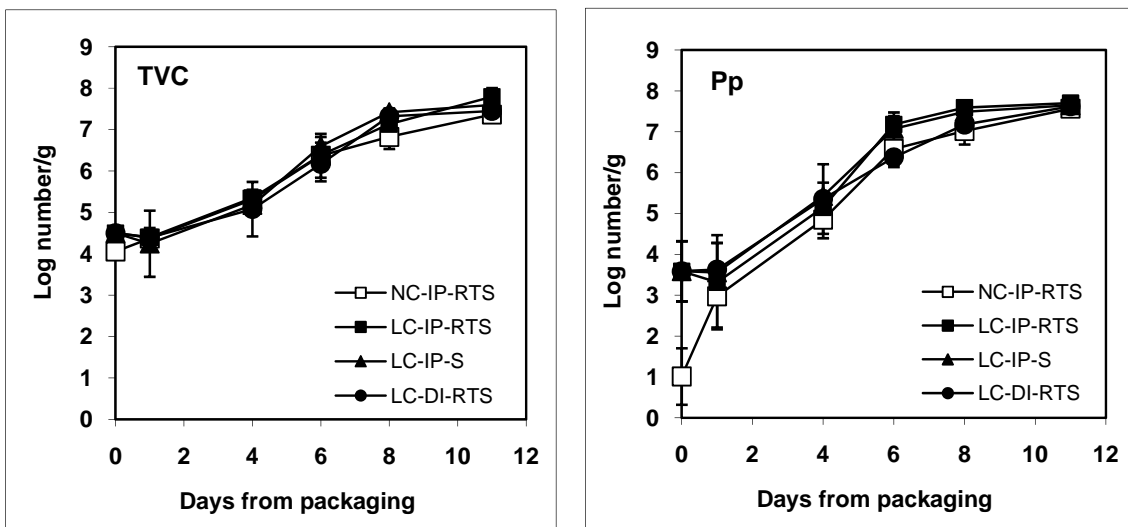

Figure 22. Total viable counts (TVC) and *Photobacterium phosphoreum* (Pp) in cod fillets (ave \pm stdev, n=3). (LC: Liquid cooling, NC: No cooling, IP: Ice packs, DI: Dry ice, RTS: Real temperature simulation, S: Steady temperature (approx. -1°C)).

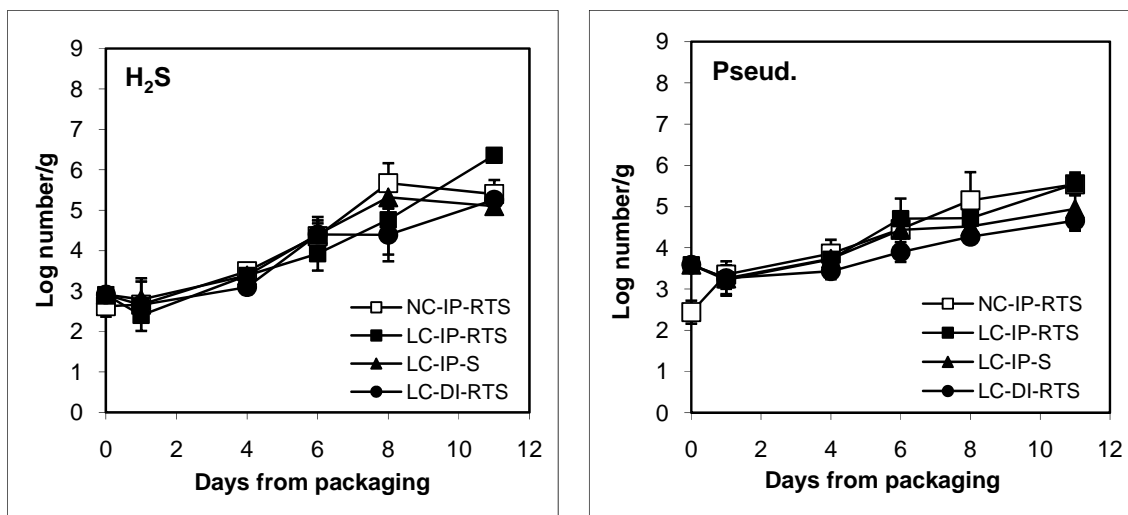

Figure 23. Growth of H₂S-producing bacteria and presumptive pseudomonads in cod fillets (ave \pm stdev, n=3). (LC: Liquid cooling, NC: No cooling, IP: Ice packs, DI: Dry ice, RTS: Real temperature simulation, S: Steady temperature (approx. -1°C)).

3.4 Chemical measurements

3.4.1 Total Volatile Base Nitrogen (TVB-N) and Trimethylamine (TMA)

No increase was observed in TVB-N and TMA content during the first four days of storage (Figure 24). After day 4, rapid increase was seen in TVB-N and TMA in all experimental groups. The TVB-N and TMA contents increased more rapidly in fillets that were cooled in liquid than in the control fillets (NC-IP-RTS). The use of dry ice (LC-DI-RTS) did though slow down formation of these substances. TVB-N values were significantly lower on day 11 in the control group compared to the groups LC-IP-RTS and LC-IP-S and TMA values were lower in the NC-IP-RTS group compared to the LC-IP-S.

The rapid increase in both TVB-N and TMA may be largely attributed to rapid growth of *P. phosphoreum* in all experimental groups but this bacterium is an active reducer of trimethylamine oxide (TMAO) to TMA. Low initial levels of this bacterium in the

control group (no cooling) have very likely led to slower formation of both TVB-N and TMA during storage in that group.

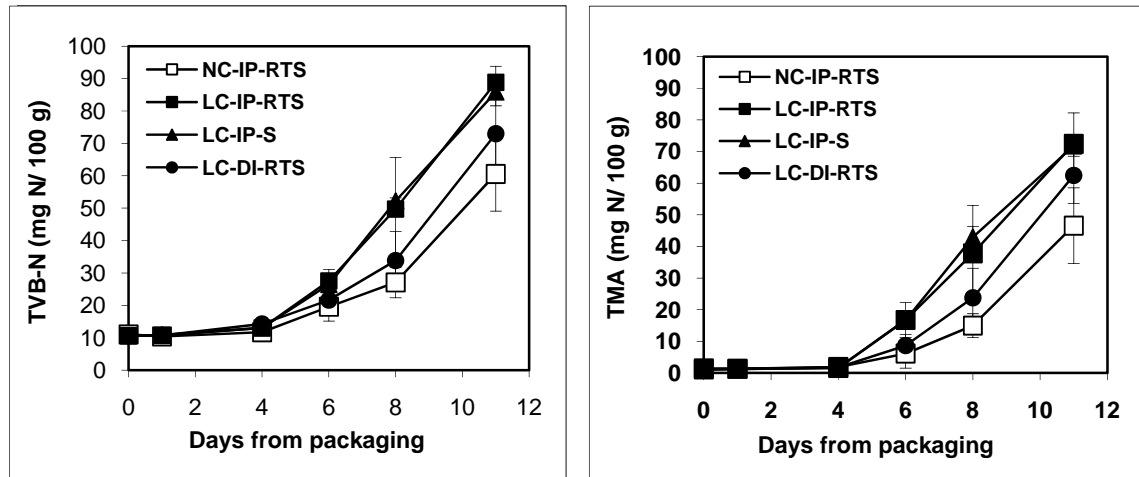

Figure 24. Total Volatile Base Nitrogen (TVB-N) and trimethylamine (TMA) in cod fillets (ave \pm stdev, n=3). (LC: Liquid cooling, NC: No cooling, IP: Ice packs, DI: Dry ice, RTS: Real temperature simulation, S: Steady temperature (approx. -1°C)).

3.4.2 pH – measurements

The pH in the fillets increased with time from day 4 after packaging (Figure). No significant differences ($p>0.05$) were found between the experimental groups at each sampling point. The pH in the brine during processing of fillets for the trial was 6.8.

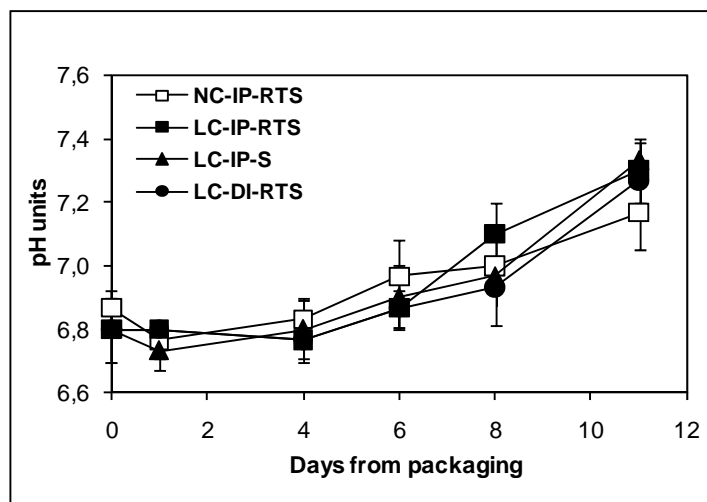

Figure 25. Acidity (pH) in cod fillets (ave \pm stdev, n=3). (LC: Liquid cooling, NC: No cooling, IP: Ice packs, RTS: Real temperature simulation, S: Steady temperature (approx. -1°C)).

3.4.3 Salt content and water content

The initial water content of the fillets was $81.6 \pm 0.2\%$. No significant changes were observed in water content with storage time ($p > 0.05$). The water content was on average slightly higher in the fillets stored superchilled (LC-IP-S) than in the control fillets (NC-IP-RTS) (Figure). Salt content was 0.3% in control fillets but 0.4% in fillets cooled in liquid before processing. The salt content of the brine at the beginning and end of processing the fillets for the trial was 1.7 and 1.5% respectively.

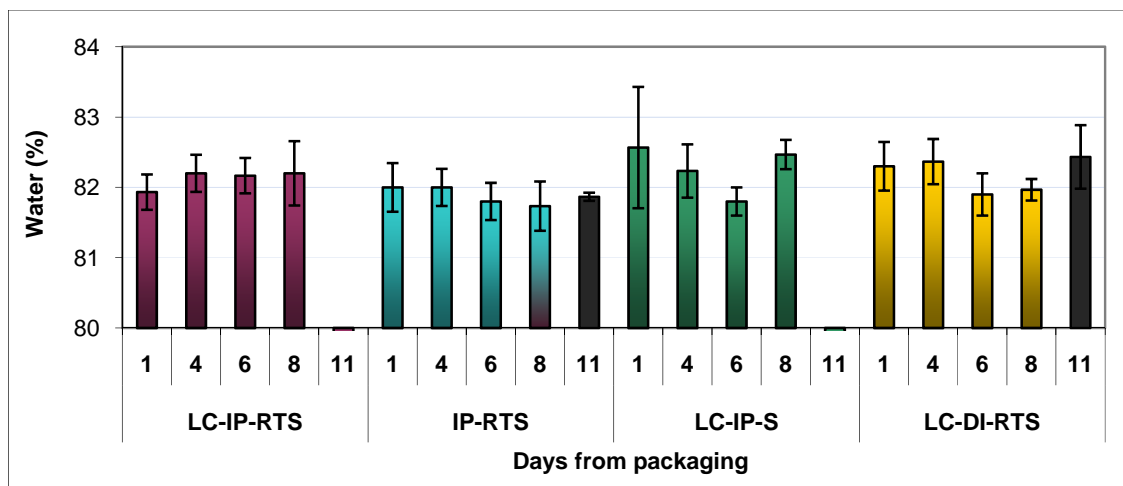

Figure 26. Water content in cod fillets (ave \pm stdev, n=3). (LC: Liquid cooling, NC: No cooling, IP: Ice packs, RTS: Real temperature simulation, S: Steady temperature (approx. -1°C)).

3.5 Water holding capacity (WHC) and drip

Changes in WHC with time were in general not significant ($p < 0.05$). Slight increases were observed in fillets stored with dry ice and in the fillets that were stored superchilled. Higher WHC correlated with higher drip with time (Figure 27) as a result of muscle degradation. The water capacity may rise as larger proportion of loosely bound water is released from the muscle.

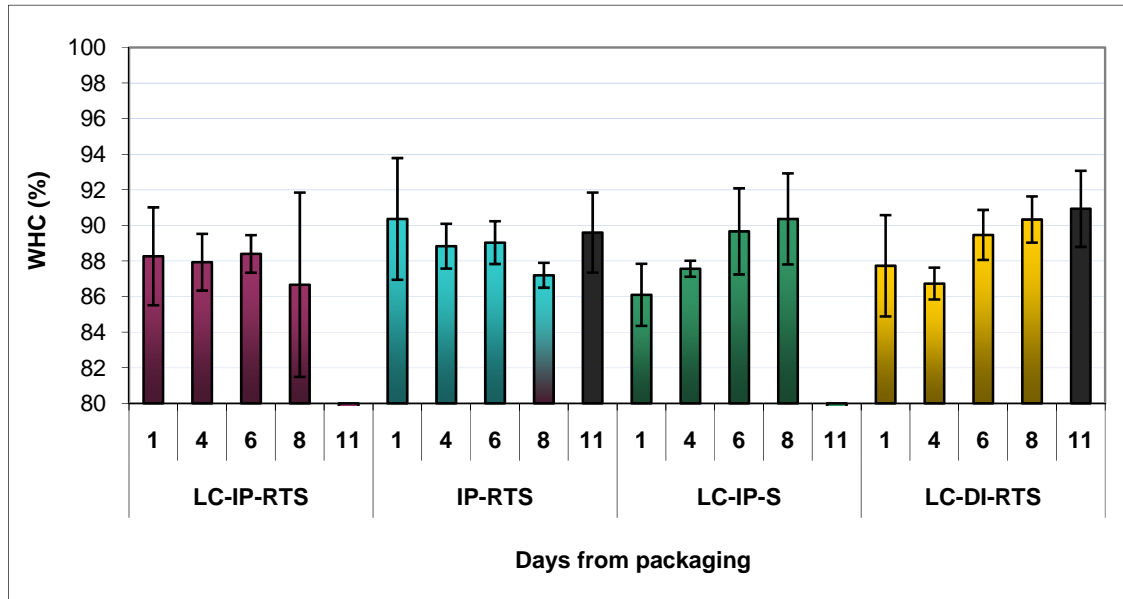

Figure 27. Water Holding Capacity (WHC) in cod fillets (ave ± stdev, n=3). (LC: Liquid cooling, NC: No cooling, IP: Ice packs, RTS: Real temperature simulation, S: Steady temperature (approx. -1°C)).

Drip increased in all groups with time (Figure 28). It was higher in the control fillets (NC-IP-RTS) at the beginning of storage but the differences levelled out during the storage period.

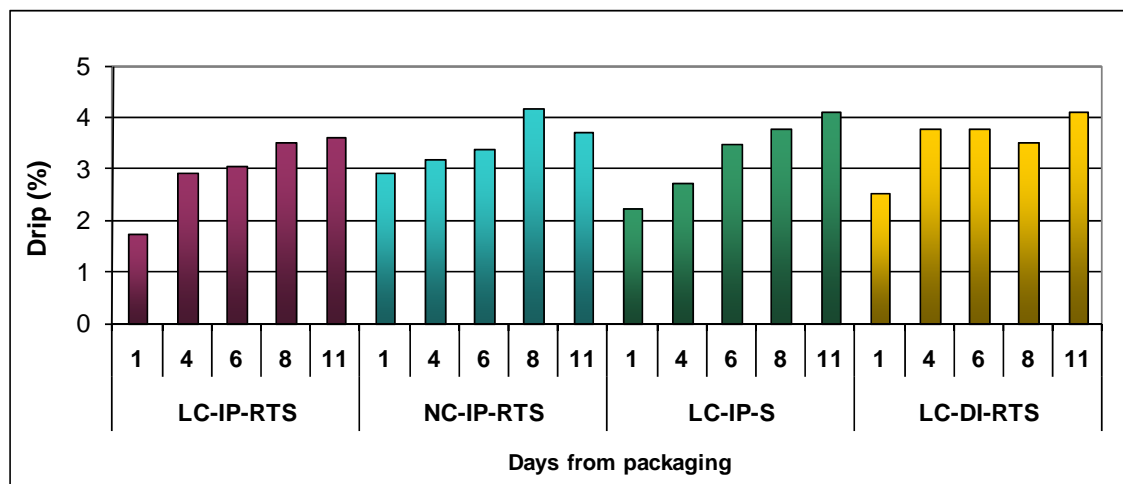

Figure 28. Drip in cod fillets. (LC: Liquid cooling, NC: No cooling, IP: Ice packs, RTS: Real temperature simulation, S: Steady temperature (approx. -1°C)).

4 CONCLUSION

Results from sensory, microbial and chemical analysis all showed that immersing the skinless cod fillets in cooling brine prior to packaging resulted in reduced shelf life in comparison with fillets that were not immersed in brine. This is attributed to the fact that the cooling brine carried considerable amounts of microbes including the spoilage bacterium *Photobacterium phosphoreum* which is an active producer of trimethylamine (TMA). If the intention is to cool fillets in brine prior to packaging it must be ensured that the brine is of high microbial quality in order to avoid the danger of cross-contamination from brine to fillet.

5 ACKNOWLEDGEMENTS

This project is a part of the research project Chill-add-on (Samþætting kælrannsóknna – Kælibót) funded by the AVS research fund under the Ministry of Fisheries (project no. R 061-06), the Technology Development Fund at the Icelandic Centre for Research (project no. 061358006) and EU-funded Integrated Research Project CHILL-ON (contract FP6-016333-2). The financing of this work is gratefully acknowledged.

6 REFERENCES

- AOAC Assn. Official Analytical Chemists. 2000. Official methods of analysis. 17th ed. Washington, D.C. (no. 976.18).
- Bonilla AC, Sveinsdottir K, Martinsdottir E. 2007. Development of Quality Index Method (QIM) scheme for fresh cod (*Gadus morhua*) fillets and application in shelf life study. *Food Control* 18 (4): 352-358
- Dalgaard P, Mejlholm O, Huss HH. 1996. Conductance method for quantitative determination of *Photobacterium phosphoreum* in fish products. *J Appl Bacteriol* 81:57-64.
- Eide O, Børresen T, Ström T. 1982. Minced Fish Production From Capelin (*Mallotus villosus*). A New Method for Gutting, Skinning and Removal of Fat from Small Fatty Fish Species. *J Food Sci* 47:347-354.
- Gram L, Trolle G, Huss HH. 1987. Detection of specific spoilage bacteria from fish stored at low (0°C) and high (20°C) temperatures. *Int J Food Microbiol* 4:65-72.

ISO 8586. (1993). Sensory analysis general guidance for the selection, training and monitoring of assessors. Part 1: selected assessors. Geneva, Switzerland: The International Organization for Standardization.

ISO The Intl. Organization for Standardization. 1999. Animal feeding stuffs - Determination of moisture and other volatile matter content. 6496. Genf, Switzerland.

Lauzon HL. 2003. Notkun Malthus leiðnitækni til hraðvirkra örverumælinga. IFL project report 30-03, 30p (in Icelandic).

Magnússon H, Sveinsdóttir K, Lauzon HL, Thorkelsdóttir Á, Martinsdóttir E. (2006). Keeping Quality of Desalted Cod Fillets in Consumer Packs. *Journal of Food Science* 71 (2): 69-76.

Malle P, Tao SH. 1987. Rapid quantitative determination of trimethylamine using steam distillation. *J Food Protect* 50(9):756-760.

Olafsdottir, G, Lauzon, HL, Martinsdóttir E, Oehlenschläger J and Kristbergsson K (2006). Evaluation of Shelf Life of Superchilled Cod (*Gadus morhua*) Fillets and the Influence of Temperature Fluctuations During Storage on Microbial and Chemical Quality Indicators. *Journal of Food Science* 71 (2). S97-S109

Shewan JM, Macintosh RG, Tucker CG and Ehrenberg ASC (1953). The development of a numerical scoring system for the sensory assessment of the spoilage of wet white fish stored in ice. *Journal of Science and Food Agriculture* 4 (June), 283-298

Stanbridge LH, Board RG. 1994. A modification of the *Pseudomonas* selective medium, CFC, that allows differentiation between meat pseudomonads and Enterobacteriaceae. *Letters in Appl Microbiol* 18:327-328.

Stone, H. and Sidel, J.L. 2004. Descriptive analysis. In *Sensory Evaluation Practices*, 3rd Ed. (H. Stone and J.L. Sidel, eds.) pp. 201–244, Elsevier, Amsterdam, the Netherlands.

Sveinsdóttir K, Martinsdóttir E, Green-Petersen D, Hyldig G, Schelvis R, Delahunty C. 2009. Sensory characteristics of different cod products related to consumer preferences and attitudes. *Food Qual.Prefer.*, 20 (2), 120-132.

7 APPENDIX I

Table A-D show how the sample groups were characterized by sensory attributes. Generally, sweet and shellfish odours were very characteristic for all groups at the beginning of storage, but decreased with the storage time. Odour of vanilla/warm milk was also characteristic the beginning and during storage, but decreased at the end of storage. A hint of boiled potatoes odour of was detected at the beginning of storage, increased somewhat with storage time, but decreased again at the end of storage. Frozen storage odour was not detected, and only a hint of sulphur odour was detected in LC-DI-RTS after 11 days of storage. Odour of table cloth, TMA and sour odours were not detected in the samples at the beginning of storage. After eight days of storage, a hint of table cloth odour was detected in NC-IP-RTS and LC-DI-RTS. Table cloth, TMA and sour odours had however, become very characteristic for all groups at the end of storage; NC-IP-RTS and LC-DI-RTS after 11 days and LC-IP-RTS and LC-IP-S after eight days. The groups generally had light and even colour, but became somewhat more dark and discoloured with storage time.

Frozen storage flavour was not detected in the sample groups, but a hint of salt flavour. At the beginning of storage metallic and sweet were very characteristic of the flavour, which decreased with storage time and were hardly detected at the end of storage. Meaty flavour was evident at the beginning of storage, but decreased with storage time. Pungent, sour, TMA flavours and off-flavour were not detected at the beginning of storage. After eight days, a hint of these attributes was detected in LC-DI-RTS and LC-IP-S, but these flavours were obvious in LC-IP-RTS at the same time. After 11 days, a hint of these attributes was detected in the control sample.

At the beginning of storage, all sample groups were described with juicy texture, but decreasingly with storage time.

Table A. Average sensory scores (QDA scale 0-100%) for odour attributes.

Product	sweet	shellfish	meat	vanilla	potatoes	frozen	cloth	TMA	sour	sulphur
<i>p-value</i>	0,000	0,000	0,000	0,000	0,000	0,118	0,000	0,000	0,000	0,000
NC-IP-RTS-d01	45	48	27	41	17	0	2	1	0	1
NC-IP-RTS-d04	40	44	26	38	24	1	7	3	2	1
NC-IP-RTS-d06	34	31	20	30	31	1	6	3	3	1
NC-IP-RTS-d08	25	21	17	26	37	1	15	8	9	1
NC-IP-RTS-d11	22	17	15	19	33	2	36	27	21	5
LC-DI-RTS-d01	49	50	25	45	14	1	1	0	1	1
LC-DI-RTS-d04	47	44	27	39	25	1	5	3	2	1
LC-DI-RTS-d06	33	33	20	30	33	2	7	6	2	1
LC-DI-RTS-d08	29	21	18	26	35	2	20	10	8	2
LC-DI-RTS-d11	14	12	10	13	25	4	45	48	34	12
LC-IP-RTS-d01	42	46	25	40	19	1	2	0	1	1
LC-IP-RTS-d04	43	43	22	38	25	1	4	3	1	0
LC-IP-RTS-d06	35	29	20	32	33	1	6	9	7	1
LC-IP-RTS-d08	16	11	9	13	28	3	35	32	30	8
LC-IP-S-d01	48	50	29	38	14	1	2	1	1	0
LC-IP-S-d04	42	42	24	37	28	1	6	4	2	1
LC-IP-S-d06	32	31	18	30	38	1	7	6	5	1
LC-IP-S-d08	20	17	11	17	30	2	31	22	24	5

Table B. Average sensory scores (QDA scale 0-100%) for appearance attributes.

Product	dark	discoloured	precipitation
<i>p-value</i>	0,0037	0,0009	0,4402
NC-IP-RTS-d01	17	16	19
NC-IP-RTS-d04	18	18	24
NC-IP-RTS-d06	24	24	29
NC-IP-RTS-d08	26	23	25
NC-IP-RTS-d11	25	29	25
LC-DI-RTS-d01	17	16	16
LC-DI-RTS-d04	18	20	26
LC-DI-RTS-d06	25	26	24
LC-DI-RTS-d08	26	27	20
LC-DI-RTS-d11	25	31	27
LC-IP-RTS-d01	25	25	20
LC-IP-RTS-d04	21	22	22
LC-IP-RTS-d06	26	27	26
LC-IP-RTS-d08	37	33	28
LC-IP-S-d01	18	18	19
LC-IP-S-d04	18	19	22
LC-IP-S-d06	25	27	23
LC-IP-S-d08	31	31	28

Table C. Average sensory scores (QDA scale 0-100%) for flavour attributes.

Product	salt	metallic	sweet	meat	frozen	pungent	sour	TMA	off
<i>p-value</i>	0,903	0,000	0,000	0,000	0,463	0,000	0,000	0,000	0,000
NC-IP-RTS-d01	13	48	39	27	1	2	1	1	2
NC-IP-RTS-d04	11	36	32	24	3	2	3	2	5
NC-IP-RTS-d06	8	32	28	18	4	3	2	4	5
NC-IP-RTS-d08	12	19	20	19	4	8	8	5	12
NC-IP-RTS-d11	13	13	18	15	1	10	16	16	18
LC-DI-RTS-d01	16	50	49	26	1	1	1	0	0
LC-DI-RTS-d04	16	38	42	25	3	3	4	1	3
LC-DI-RTS-d06	15	30	31	21	3	6	4	6	6
LC-DI-RTS-d08	14	22	26	18	2	8	13	10	14
LC-DI-RTS-d11	15	10	10	8	4	16	26	38	32
LC-IP-RTS-d01	16	49	41	27	1	1	1	1	1
LC-IP-RTS-d04	15	39	42	25	3	3	3	3	3
LC-IP-RTS-d06	10	30	30	18	5	7	4	9	10
LC-IP-RTS-d08	15	9	18	11	4	15	21	24	30
LC-IP-S-d01	16	48	48	26	1	1	1	0	1
LC-IP-S-d04	17	32	39	24	3	3	4	2	3
LC-IP-S-d06	12	28	31	22	4	4	5	4	7
LC-IP-S-d08	13	15	19	16	4	13	15	17	21

Table D. Average sensory scores (QDA scale 0-100%) for texture attributes.

Product	flaky	soft	juicy	tender	mushy	meaty	clammy	rubbery
<i>p-value</i>	0,9441	0,932	0,0354	0,732	0,0732	0,3188	0,9932	0,4553
NC-IP-RTS-d01	53	64	65	60	28	36	19	12
NC-IP-RTS-d04	54	63	61	61	28	36	18	14
NC-IP-RTS-d06	52	67	56	62	32	29	22	12
NC-IP-RTS-d08	54	65	60	57	37	33	25	15
NC-IP-RTS-d11	54	64	57	54	31	34	17	13
LC-DI-RTS-d01	51	68	72	66	32	35	19	9
LC-DI-RTS-d04	59	58	61	59	24	39	20	14
LC-DI-RTS-d06	58	66	54	55	27	37	18	16
LC-DI-RTS-d08	59	68	61	62	35	31	16	8
LC-DI-RTS-d11	55	70	61	63	33	31	19	8
LC-IP-RTS-d01	59	67	65	65	21	36	19	10
LC-IP-RTS-d04	56	63	62	59	29	37	22	18
LC-IP-RTS-d06	56	63	60	58	29	31	21	14
LC-IP-RTS-d08	62	66	53	61	39	30	18	9
LC-IP-S-d01	57	68	70	65	26	31	19	8
LC-IP-S-d04	58	68	65	67	33	31	16	8
LC-IP-S-d06	55	66	62	61	37	29	17	11
LC-IP-S-d08	56	68	62	63	38	29	16	11

Table E. Averages of microbiological and chemical data. Statistical comparison of sample groups within each sampling day. Sample groups with different letters are different within a column. (TVC: Total viable count, Pp: *Photobacterium phosphoreum*).

Group	TVC	H2S-prod.	Pseudomonas	Pp	pH	TVB	TMA
Day 0							
p-value	0,003	0,155	0,002	0,012	0,374	0,433	0,310
KMN: LC	4,5 ^a	2,9	3,6 ^a	3,6 ^a	6,8	10,6	1,1
L: NC	4,1 ^b	2,6	2,4 ^b	1,0 ^b	6,9	11,0	1,5
Day 1							
p-value	0,969	0,698	0,964	0,777	0,219	0,838	0,931
K: LC-IP-RTS	4,4	2,4	3,2	3,3	6,8	10,7	1,3
L: NC-IP-RTS	4,4	2,7	3,4	3,0	6,8	10,4	1,4
M: LC-IP-S	4,2	2,8	3,3	3,6	6,7	10,9	1,2
N: LC-DI-RTS	4,4	2,7	3,3	3,6	6,8	10,7	1,3
Day 4							
p-value	0,804	0,061	0,158	0,547	0,627	0,302	0,961
K: LC-IP-RTS	5,3	3,4	3,7	5,1	6,8	13,0	1,6
L: NC-IP-RTS	5,3	3,5	3,9	4,9	6,8	11,7	1,9
M: LC-IP-S	5,2	3,4	3,7	5,4	6,8	13,1	1,6
N: LC-DI-RTS	5,1	3,1	3,4	5,4	6,8	14,3	1,8
Day 6							
p-value	0,623	0,403	0,100	0,123	0,487	0,115	0,013
K: LC-IP-RTS	6,4	3,9	4,7	7,2	6,9	27,5	16,7 ^{ab}
L: NC-IP-RTS	6,4	4,4	4,5	6,6	7,0	19,6	6,1 ^c
M: LC-IP-S	6,6	4,4	4,4	7,1	6,9	26,4	16,7 ^a
N: LC-DI-RTS	6,2	4,4	3,9	6,4	6,9	21,6	8,7 ^{bc}
Day 8							
p-value	0,057	0,125	0,148	0,104	0,256	0,493	0,397
K: LC-IP-RTS	7,1	4,8	4,7	7,6	7,1	49,7	37,8
L: NC-IP-RTS	6,8	5,7	5,1	7,0	7,0	27,1	15,0
M: LC-IP-S	7,4	5,3	4,5	7,5	7,0	34,8	28,6
N: LC-DI-RTS	7,3	4,4	4,3	7,2	6,9	33,8	23,8
Day 11							
p-value	0,051	0,001	0,029	0,100	0,274	0,018	0,042
K: LC-IP-RTS	7,8 ^a	6,4 ^a	5,6	7,7	7,3	88,8 ^a	72,4
L: NC-IP-RTS	7,4 ^b	5,4 ^b	5,5 ^a	7,6	7,2	60,6 ^b	46,6 ^b
M: LC-IP-S	7,6	5,1 ^b	4,9	7,6	7,3	85,9 ^a	71,8 ^a
N: LC-DI-RTS	7,4	5,3 ^b	4,7 ^b	7,6	7,3	73,0	62,4